



Sparkhomes.com.au

SPARK BUSINESS GROUP

Email: enquiry@sparkbusinessgroup.com.au Website: sparkhomes.com.au

Unit 3, 13 McCormack Street, Arndell Park, 2148 NSW

Telephone: (02) 88074717, (02) 86787856

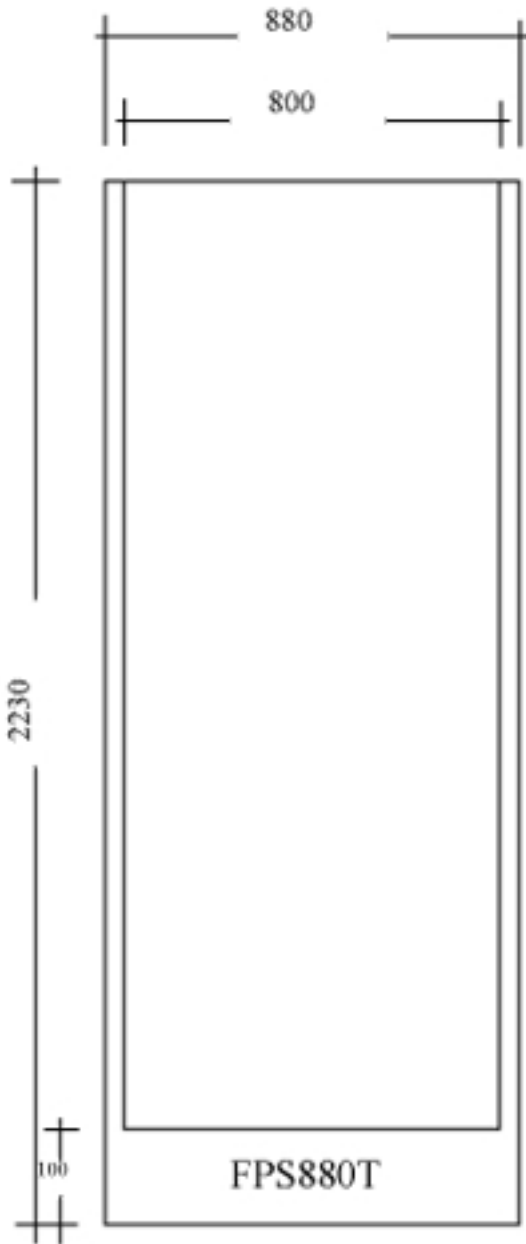

880x850 Flat Packed Shower

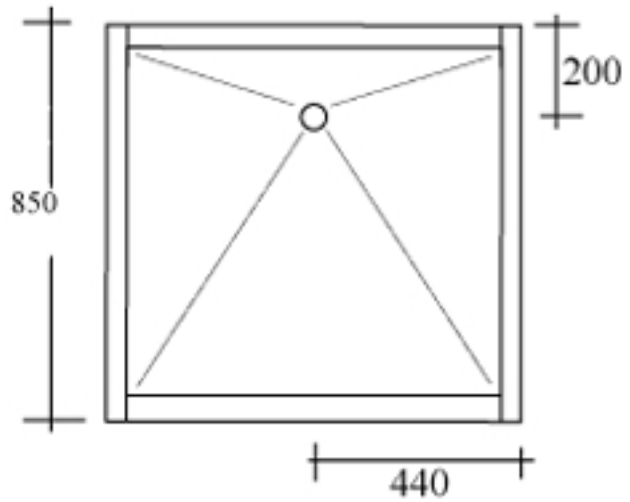

Sizes are nominal and may vary slightly from batch to batch.